

CABLE MANAGEMENT

Welcome to our pocket guide to cable management. You are strongly recommended to read it prior to planning and installing the cables provided with equipment from Atlas Copco Industrial Technique.

As with many industrial systems, cables are a main failure point especially in applications where the cables are subject to repetitive motion. Atlas Copco has developed this pocket guide to help you find effective solutions to your facilities unique cable needs. It includes information developed from Atlas Copco's many years of industrial experience and will help in limiting your cable relative failures.

For additional information or assistance, please contact your Atlas Copco representative.

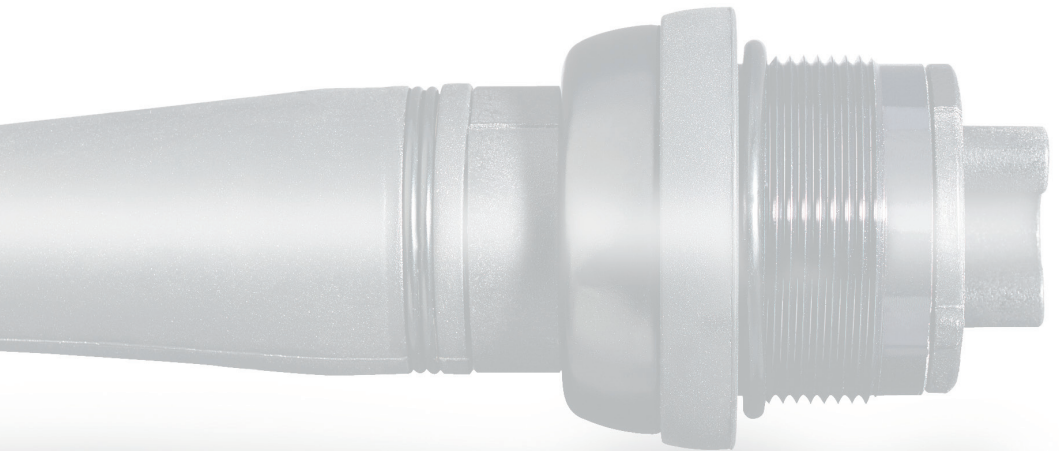

CONTENTS

Chapter.....	Page
1. Definition of cable management.....	4
2. Cable management for fixtured tools/torque tubes.....	5
2.1 Overview of fixtured tools.....	5
2.2 Setting tool cable length in relation to restraint cables.....	6
2.3 How to fixture an angle tool.....	6
2.4 Special tools.....	6
3. Cable management for handtooling using a cable balancer.....	7
4. Cable management for resting the tool.....	9
4.1 Tools tray.....	9
4.2 Tool hook.....	9
4.3 Suspension yoke.....	9
5. Cables.....	10
5.1 Benefits of a flat cable.....	10
5.2 Bending radius for tool cables.....	12
5.3 Recommended cable length.....	13
6. Protection of cables using cable accessories.....	14
6.1 Accessories.....	14
7. Securing the cable.....	15
7.1 Use common sense when securing cables.....	15
7.2 Method of securing the cable.....	17
8. Check points.....	18
8.1 Before installation.....	18
8.2 During the installation.....	19
8.3 After the installation.....	21

1. DEFINITION OF CABLE MANAGEMENT

Cables are used in conjunction with all Atlas Copco tools and assembly equipment, including: handheld tools, fixtured hand tools or when spindle “motors only” are provided for incorporation into various types of machine automation.

In the case of fastening equipment, cables connect the following functions:

- Power supply
- Controller
- Nutrunner
- Accessory

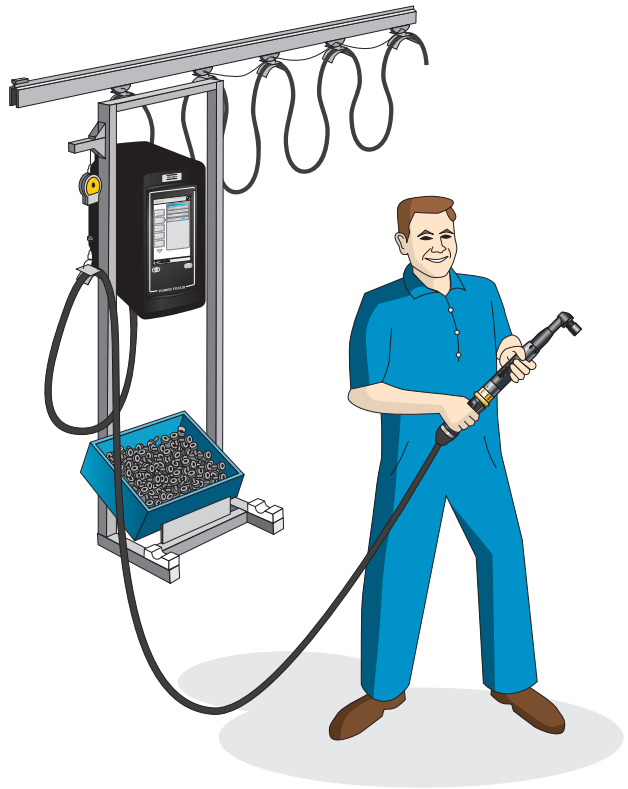

Tool tray, see page 9.

2. CABLE MANAGEMENT FOR FIXTURED TOOLS/TORQUE TUBES

2.1 Overview of fixtured tools

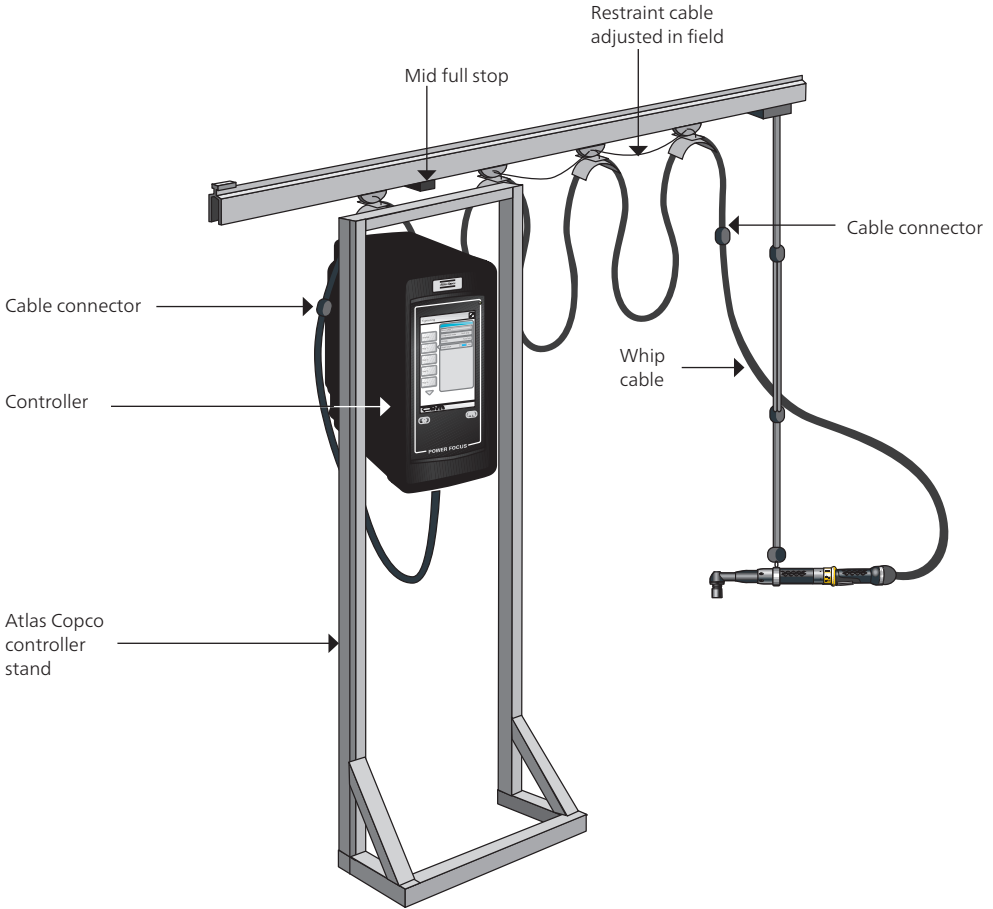

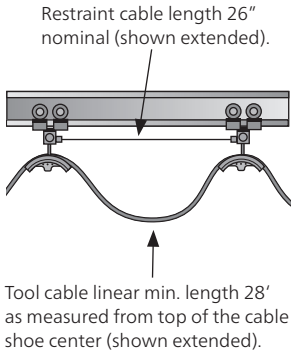

2.2 Setting tool cable length in relation to restraint cables

(Hand tool cable shown).
Note:

This view shows a typical hand tool cable installation on Atlas Copco cable shoe(s).

- Final adjustment should be made on site to suit conditions.
- Tool cable lengths may vary due to foot traffic or work station requirements and will then require a shorter restraint cable adjustment.
- Restraint cable length must always be shorter than tool cable length to limit cable stress (as shown).

The illustration serves as a basic guideline for mounting options. As you can see in the illustration, the mounting options are broken down into three categories:

- Primary
- Secondary
- No Mounting Allowed

2.3 How to fixture an angle type tool

(Hand tool Tensor ST shown).

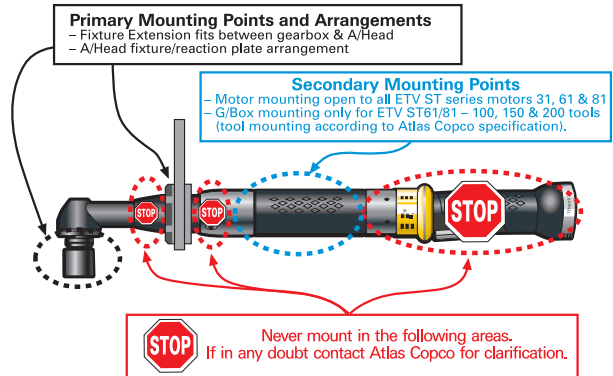

2.4 Special tools

Specials are best defined as all other tool options, including

- H.A.D. (Hold and Drive) tools
- F.S. (Flush Socket) tools
- Tools fitted with external electric accessories, such as Bar Code scanner, P-Set selector, I/O bit selector, etc.
- and any other adaption, except for the standard ETV angle tools.

In cases where these special types of tool are being considered for mounting to any form of end effector, torque tube etc. and/or the direct fitment of a reaction device onto any part of the tool body, you are strongly advised to seek the support and approval of Atlas Copco Tools.

3. CABLE MANAGEMENT FOR HAND TOOLING USING A CABLE BALANCER

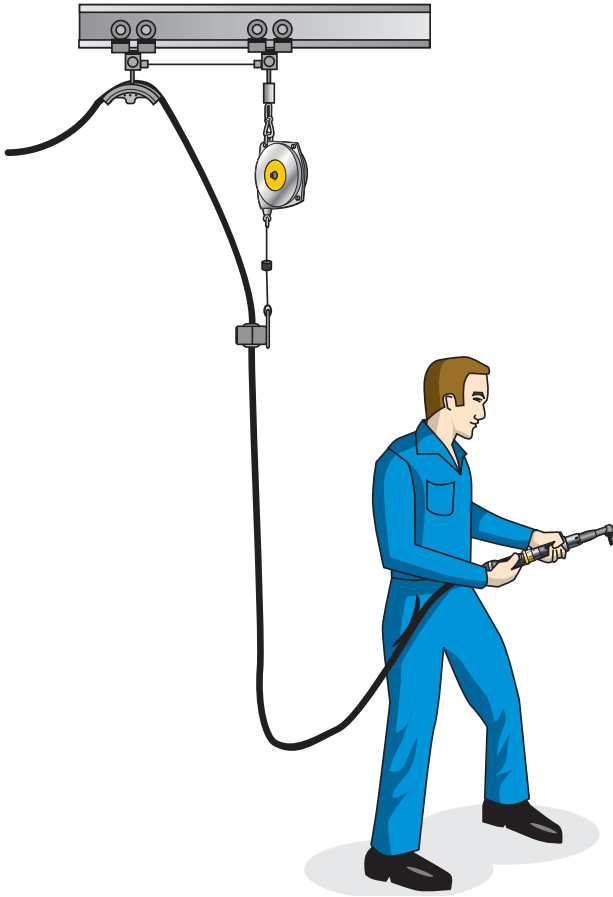



Note:
Adjust restraint cable lengths and electrical cable length such that the length of the restraint cable between cable trolleys is shorter than that of the electrical cables between trolleys.

A cable balancer helps to manage the excess cable when the tool and cable are not extended.

Also shown above is the use of a cable clamp bracket. This bracket is used to attach the cable balancer to the cable.

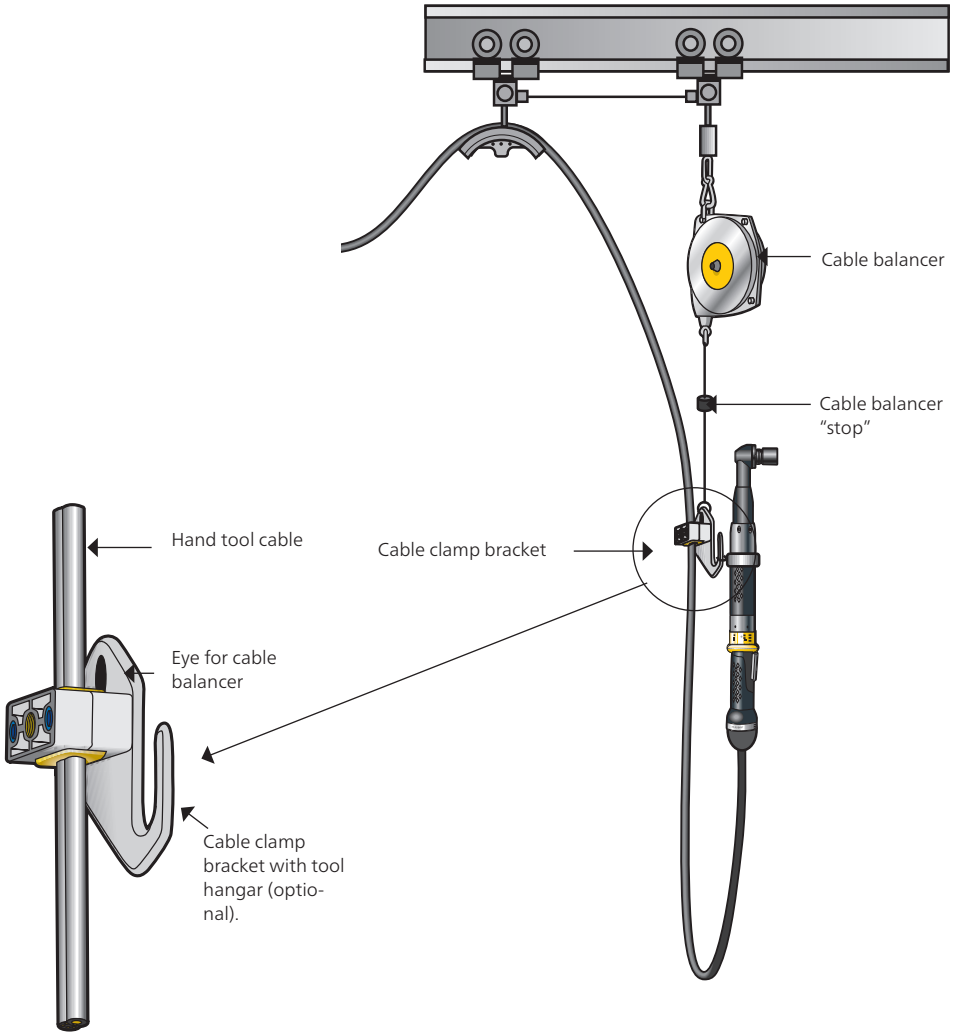
A cable balancer is equipped with a "stop" (shown above) and its tension is adjustable, thus enabling a specific set up at the workstation to suit the operator.

Cable clamp bracket

This clamp bracket can be attached to a hand tool cable and then be attached to a cable balancer. When located properly on the tool cable, the cable balancer will maintain the cable off the floor. A hook is provided as a place to "rest" the tool and may be used with or without a cable balancer to "rest" the tool when the cable is spread over the cable shoe.

4. CABLE MANAGEMENT WITH REGARD TO RESTING THE TOOL

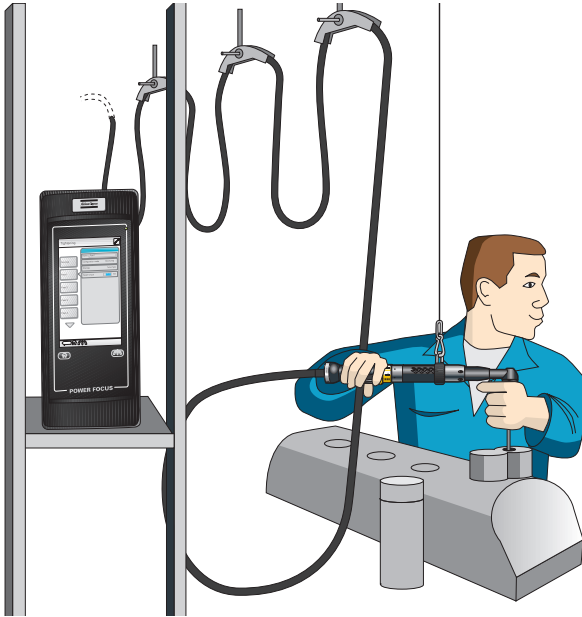

Hand tool using suspension yoke.

4.1 Tool tray

When a hand tool is not attached to a torque tube balancer, cable balancer or support/suspending element, a tool tray or tool hook should be provided. Hand tools and cables are subjected to rough treatment and misuse when the operator is not provided with a convenient place to rest the tool safely.

4.2 Tool hook

Atlas Copco offers a bracket that clamps onto the tool cable to provide a place to hang the tool. Suspension yokes are available for attaching to the tool. They have an eyelet that can be used to hang the tool by means of a hook. (See page 4).

4.3 Suspension yoke

A "suspension yoke" is available for almost all Atlas Copco hand tools. There are various types of yoke to suit the requirements of different tools.

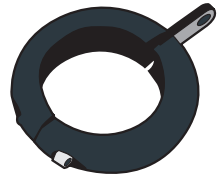

Suspension yokes

5. CABLES

5.1 Benefits of flat cable

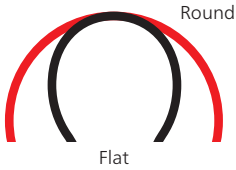

Flat cable for greater durability

Atlas Copco has been producing assembly tool cables since 1987 and has unrivalled experience in the field. Flexibility and durability have steadily improved since the introduction of the company's first-generation cables, resulting in today's optimum cable performance. Atlas Copco's flat-cable design combines maximum flexibility (for access to difficult applications) with maximum durability. No other manufacturer can offer such a potent combination of flexibility and performance.

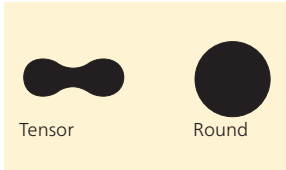

Smaller bending radius for greater accessibility

Atlas Copco engineers its tool cables to withstand consistent and long-term flexing. Cable size (diameter) is the most critical factor in terms of flex life. The best way to reduce fatigue affecting the internal cable conductors is to keep cable thickness to a minimum. Atlas Copco's flat-cable design is just under half the thickness of a comparable "round" cable, offering an exponential gain in flex life. When it comes to durability and flexibility, the Atlas Copco cable is unique.

Innovative 'Cable Twist' design

The most critical area for an assembly tool cable is at the point of maximum flex – generally close to the tool connection point. Atlas Copco's "Cable Twist" design spreads the flex load over a greater distance, to minimize flex in the critical area. This patented flat-cable "twist" design is unique to Atlas Copco.

Centralized strain relief to prevent lead damage

The flat-cable design features a Kevlar-reinforced core, to absorb the tensile loads to which cables can be subjected in tough applications. When subjected to high tensile loads, this centralized load-relief Kevlar core also prevents cable leads being damaged or compressed, as happens with most round cable designs which have the strain relief outside the cable leads. For maximum signal integrity, the flat cable design also ensures optimum separation of high and low voltage conductors.

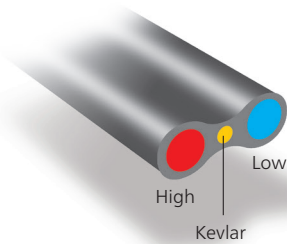

Types of cable available

Various types of cable are available from Atlas Copco to suit all kinds of applications, as illustrated below.



Tensor Tool Cable.

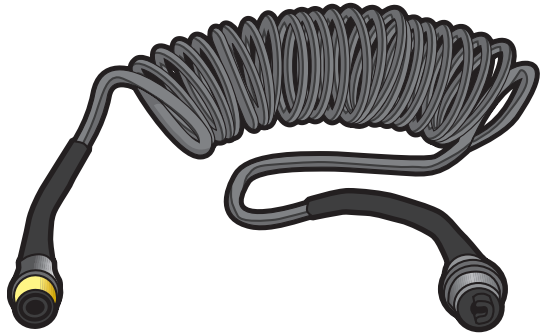

Tensor Spiral Cable.

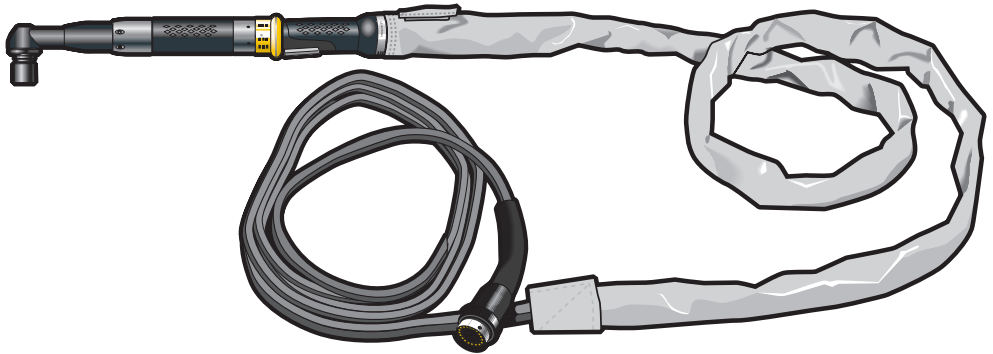

Cable cover for workpiece surface protection.

5.2. Bending radius for tool cables

All Atlas Copco tool cables are designed to be bent or flexed. However, a related and frequently asked question is – how tightly can you bend a cable without damaging it?

The answer depends primarily on the specific cable being considered for the tool involved.

What is the minimum bending radius? Take a look at the illustration to the left:

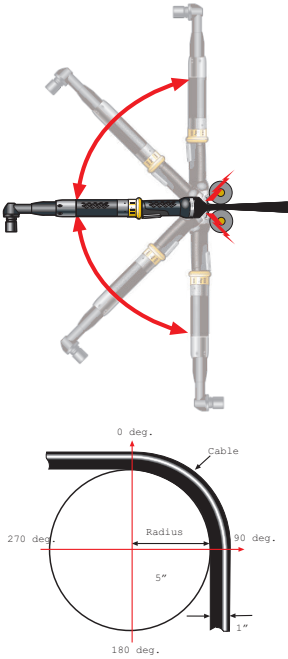

Testing the cable by bending it 180 degrees.

In the drawing, a cable is being bent around a radius of 5". The bend could be the result of pulling a cable around a curve in an above ground conduit or underground duct. It could also be the result of laying the cable in the bend of a cable tray.

The radius of a circle is always half the diameter. In the wire and cable industry, we usually give the minimum bending radius as a multiple of the cable diameter.

Below you can find a table of minimum bending radii for various cable types:

The rated voltage of the cables mentioned below should not exceed 0.6/1 kV.

Flexible cables	Up to 8 mm diameter	Over 8 to 12 mm diameter	Over 12 to 20 mm diameter
Cables in trays	4 d	5 d	5 d
Cables in free mode	7 d	8 d	12 d
Forced operation (wind)	7 d	7 d	7 d
Chain operation	6 d	6 d	7 d
Rolling detour	10 d	10 d	10 d

Thus 4 d for an 8 mm diameter cable in a tray means that the minimum bending radius is 32 mm.

Designation	Chemical	VDE	Max. working temperature, °C	Tensile strength [N/mm ²]	Stretch %
PUR	Polyurethane	11 Y	80	35–50	500–700

Cable material = Polyurethane

5.3 Recommended cable length

This section describes recommended cable lengths for Atlas Copco tool cables for Tensor ST/SR/STR/ETX/QST. The cable is used to make the connection between the following components:

- Controller
- Tool (straight, angle, pistol, fixtured)

The cables for Tensor ST and Tensor SL are designed to carry digital-only signals between the controller and the tool card. The characteristics of the digital signals enable transmission in longer cables compared to analogue signals.

In the table below you can see the recommended cable length for our handheld and fixtured tools:

Tool type	Signal type	Recommended cable length [m]
Tensor S	Analogue	20
ETX	Analogue	25
QMX	Analogue	30
QST 34/42/50/62	Digital	60m (3x20m OK, 6x10m NOK)
QST 80/90/95	Digital	50m (2x20m+1x10m OK, 5x10m NOK)
Tensor ST 31, 61, 81	Digital	50
Tensor STR	Digital	50
Tensor ST 101	Digital	30
Tensor SR	Digital	50
Tensor SL up to 12Nm	Digital	20
Tensor SL 20Nm	Digital	15



No liquid.



No sharp objects.



No open fire.
No heat.



No chafing.



No vibrations.



No corroding fluids.

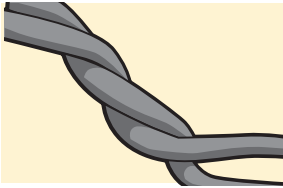

Don't twist cables.

6. PROTECTION OF CABLES USING CABLE ACCESSORIES

Cables need to be protected throughout their routing. What are we protecting cables from?

- People
- Equipment
- Machine movement
- Chafing
- Sharp objects
- Vibration
- Heat
- Liquid

Cable routing installations may vary but one of a few common methods and components will normally suit the requirements of the particular situation.

Cable tray systems, "cat track", cable festooning, cable shoes and cable conduit are commonly used to protect cables.

6.1 Cable management accessories

The following accessories are available from Atlas Copco for cable management applications.

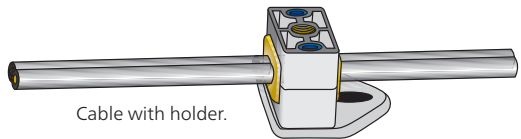

Cable with holder.

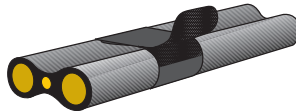

Wraps.

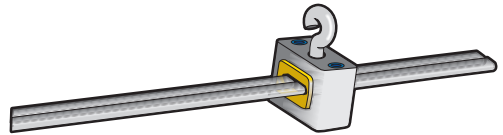

Cable holder with hook.

7. SECURING THE CABLE

7.1 Use common sense when securing cables

Typically, the greatest wear and tear on cables is caused by securing them incorrectly. The improper use of tie wraps, clamps, straps, tape, etc., are common causes of cable problems.

Examples:

- Over-tightening – tears cable covers, causes kinks and can create “hot spots”.
- Incorrect securing may restrict cable movement and exert a corkscrew effect on the cable.
- Incorrect securing can place excessive strain on cable connectors.
- Use of “tie wraps”, straps, tape, etc., may place unnecessary strain on cables. Cables that move need reasonable freedom of movement.
- Poor placement when securing cables forces repetitive bending at a given point rather than over a length of cable. Try to bend/flex over a greater length of cable.
- Remember it is important to stretch out and relax cable(s) prior to securing in order to remove cable “memory” following shipping/packing.

Use common sense when securing cables!



Do not over-tighten the cable.

General cable mounting and securing

This section shows ways of prolonging cable life by minimizing bending stresses.

1. Use the optimum cable length

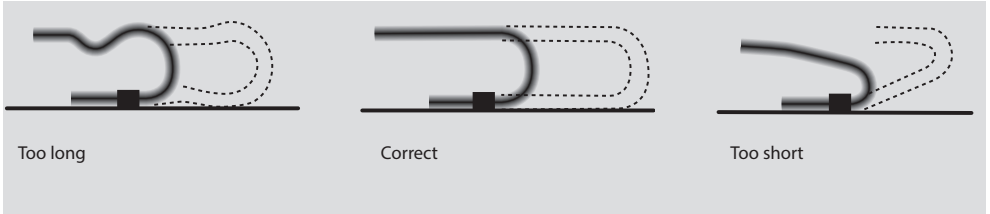

2. Use large bending radius

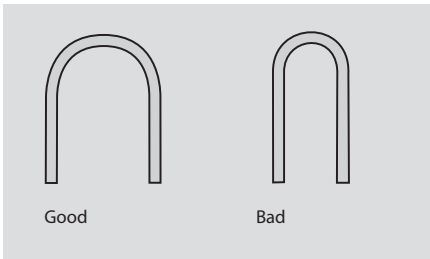

See page 13.

3. Use connectors with sleeves

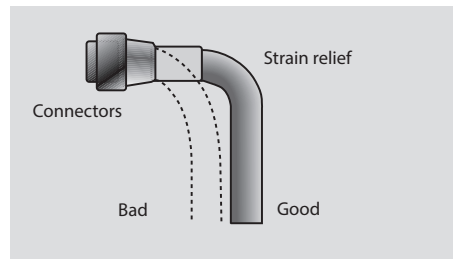

4. Don't tie cables at flex points

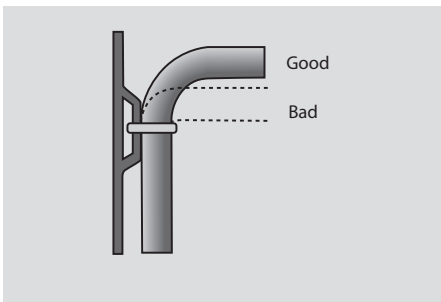

5. Don't tie random size cables together, especially at flex points

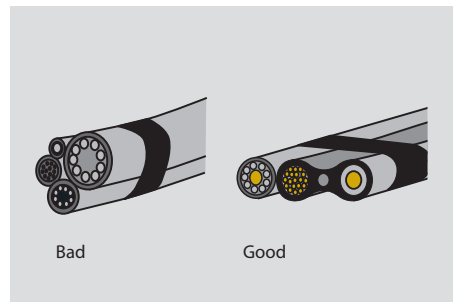

7.2 Methods of securing the cable

Hand tools and cables

Moving in, out, over, under and around a given fastening operation exposes cables to sharp edges, rough pointed surfaces, pinch points and snags. These types of situation commonly cause the greatest abuse to cables. Attention to protecting cables from excessive exposure to these cable damaging conditions needs to be evaluated when designing the cable management system.

Whip cables

A specific fastening operation may have foreseeable cable damaging aspects which are unavoidable. In these instances a shorter “whip cable” can be provided with the expectation of replacing this intermediate, less expensive cable as required. The use and proper placement of a “whip cable” will also make cable replacement less time consuming. The use and stocking of a spare “whip cable” is recommended for practically any application, whether it be a hand tool or a fixtured tool operation.

Panel/controller location

Panel/controller location must be determined in order to best specify cable length(s). Although panels for fixtured tools (non hand tools) are typically lagged to the floor, hand tool controllers may not be in a fixed position. Controllers may be mounted on Atlas Copco “stands” which may then be fastened to the floor or casters used. Controllers can also be mounted on a frame equipped with trolleys for use on a tool rail, allowing it to be moved along with the tool on the tool rail. Ultimately the length of cable should be specified by identifying the panel/controller location, the allocation for cable routing and the amount of “working travel” required by the operator.

8.CHECK LIST

8.1 Before installation

1. The cables must be prepared for installation by removing any twists, bends or kinks in the cable.
2. When unpacking the cables, remove any tie wraps used during shipping.
3. Before insertion in the cable tray or track, and before use of overhead suspension, it is important that the cable(s) be laid out or hung prior to installation long enough to relax any stresses and remove any "memory" resulting from packaging, transit or storage.
4. If the cables cannot be relaxed, they should be shaken out. Grasp the length of cable at its mid-point and shake the cable as you move your hands to each end. Wrap the cable ends with masking tape and mark the top of each.
5. Maintain this alignment throughout installation, clamping and binding.
6. Use the most direct path when routing cables.
7. Ensure connectors do not come in contact with any fluid.
8. Route cables away from any type of fluid.
9. Avoid running cables directly next to high voltage (440V or higher) or high frequency lines.
10. Cables must be protected from impact by sharp objects. Always check for possible chafing points.
11. Controller location must be determined in order to best specify cable length(s).

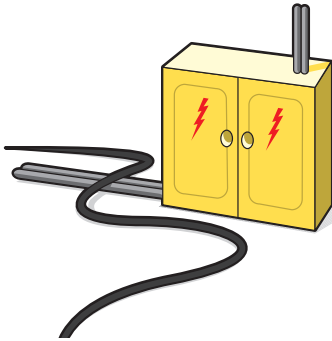
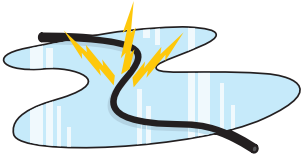

8.2 During the installation

1. The minimum recommended bending radius of the cable should not be exceeded (see page 12). When multiple cables are in use, the cable with the greatest overall dimension should be used in calculating minimum radius. It is best to follow the rule that “big bends are best”. The minimum bending radius must be increased when repeated flexing will occur at given point on the cables.
2. Protect cable connectors from impact that will cause damage, such as dropping cables from elevated cable tray to floor level.
3. Do not weave cables between each other or wrap them around each other. Cables and/or hoses from other tools should not share hangers, trolleys, etc.
4. Do not secure cables at a connector, leave at least 5 inches between connector and cable straps, cable clamp, etc. with the optimum goal of zero movement (including vibration) at the connector.
5. Cables must be protected from impact by sharp objects. Always check for possible chafing points.
6. Cable shoes provided with equipment are for cable support and should be utilized as such. Cables must be supported near connectors on the panel and at the operator end to avoid strain on plugs and sockets. Cables are not intended to be used as a structural element, they must not be pulled/pushed or be subjected to any other kind of stress or load.
7. Atlas Copco recommends never using tie wraps unless they include the use of additional material between the tie wrap and the cable such as flexible tubing through which the tie wrap will run.
8. Do not tie anything of any kind to cables, or hang anything from them.

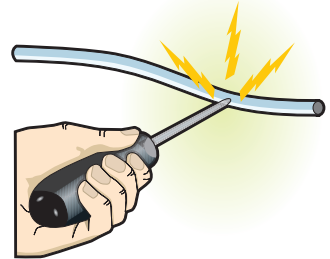

9. Cables hung using a festooning type system must be secured to the individual cable trolley/saddle, avoiding sharp bends and be positioned to eliminate or minimize any torsion twisting. Cables must be routed properly to ensure ease of movement and eliminate any foreseeable wear or damage.
10. Strain relief cables should be used between cable trolleys to eliminate pulling and stretching of cables by the operator when repeatedly positioning tool.
11. Cable loops should be consistent in length and typically not exceed 5 feet in depth between trolley saddles. Sufficient trolleys should be present in the system to support the entire length of moving cable and allow relaxed stacking of cable loops when the tool is in the idle, retracted, position.
12. Rail stops, end of travel stops and rotation limits should be incorporated into the system to prevent excessive cable wear and protect against over travel damage and torsional twisting.
13. Restraint cable length must always be shorter than tool cable length to limit cable stress.

8.3 After the installation

1. Route cables away from the operator, clear of worker traffic and away from any suspension obstructions.
2. Do not tie or hang anything whatsoever from cables.
3. All trolley and moving cable/tool suspension devices should be checked for ease of movement related to lubrication and general maintenance.
4. After cable is installed, it should be cycled through several flexes and checked for freedom of movement. It is important to ensure that cables can move with complete freedom within the radius, permitting movement of cables among themselves.
5. Cooling access cable is not recommended. Laying the cables out and back beside themselves with the minimum amount of overlapping is the preferred method.
6. Final adjustment should be made on site to suit conditions.

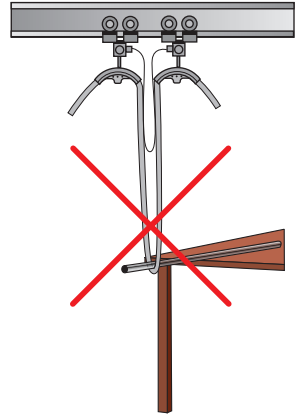

POCKET GUIDES FROM ATLAS COPCO INDUSTRIAL TECHNIQUE

Title	Ordering No.
Air line distribution	9833 1266 01
Air motors	9833 9067 01
Cable management	9833 1640 01
Drilling with handheld machines	9833 8554 01
Error proofed production	9833 1437 01
Grinding	9833 8641 01
LEAN	9853 8215 01
Percussive tools	9833 1003 01
Power Tool Ergonomics (book)	9833 1162 01
Pulse tools	9833 1225 01
Riveting technique	9833 1124 01
Screwdriving	9833 1007 01
Statistical analysis technique	9833 8637 01
Testing and calibration in assembly technology	9833 1720 01
The art of ergonomics	9833 8587 01
Tightening technique	9833 8648 01
Vibrations in grinders	9833 9017 01
Vibration exposure assessment for power tools	9833 1508 01

The Atlas Copco logo consists of the brand name in a stylized, italicized serif font, centered between two horizontal white bars.

Atlas Copco AB

(publ) SE-105 23 Stockholm, Sweden

Phone: +46 8 743 80 00

Reg. no: 556014-2720

atlascopco.com

